

HARDWARE





NUTS, BOLTS & WASHERS

GRADE 5 BOLT ASSEMBLIES, GALVANIZED [HEX BOLTS, NUT & LOCKING DEVICE]

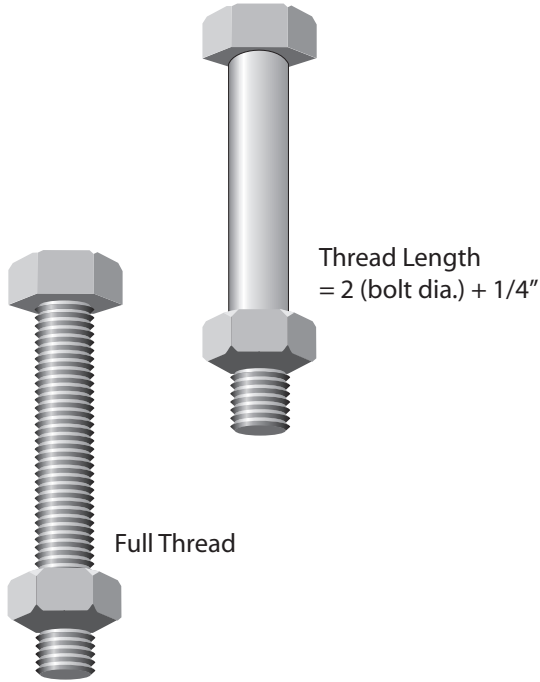

Dia. x Length (inches)	Assembly Part No.	Weight (lbs./100pcs)
5/16 x 2-3/8	210003GA	7/100
3/8 x 1-1/4	210005GA	10/100
3/8 x 1-1/2	210008GA	10/100
3/8 x 2	210009GA	12/100
3/8 x 2-1/2	210011GA	13/100
3/8 x 2-1/2 (Full Thread)	210176GA	13/100
3/8 x 4	210014GA	18/100
3/8 x 4 (Full Thread)	210013GA	18/100
7/16 x 2-1/2	210016GA	17/100
5/8 x 1-3/4	210146GA	35/100
5/8 x 2	210140GA	38/100
5/8 x 3-1/4	210036GA	51/100
5/8 x 3-3/4	210038GA	53/100
3/4 x 4-1/2	210091GA	91/100
7/8 x 3	210062GA	103/100

Pal nuts included with assembly P/N shown.
See table below for other nut locking devices.

NUT LOCKING DEVICE OPTIONS [ADD SUFFIX AFTER BOLT ASSEMBLY PART NUMBER]

Suffix	Nut Locking Device
-	Pal Nut
AN	Anco Nut
TLN	Tri-Loc Nut
LW	Split Ring Washer

Example:

For 3/8" x 1-1/2" bolt assembly with a split ring lock washer used for a nut locking device, in place of a pal nut, order part number: **210011GALW**

NOTE: To order bolts or other hardware in this catalog without nuts and nut locking devices, remove the "A" from the end of the assembly part number.

NUTS, BOLTS & WASHERS

STRUCTURAL BOLT ASSEMBLIES, 120 KSI TENSILE STRENGTH, GALVANIZED
[HEAVY HEX BOLTS, NUTS & NUT LOCKING DEVICE]

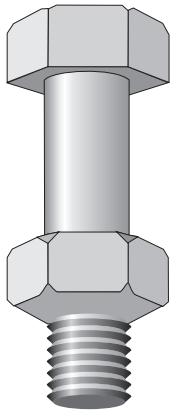

Dia. x Length (inches)	Assy. Part No.	Weight (lbs/100pcs)
1/2 x 1-1/4	210017GA	21/100
1/2 x 1-1/2	210018GA	22/100
1/2 x 1-3/4	210019GA	24/100
1/2 x 2	210020GA	25/100
5/8 x 1-1/2	210029GA	34/100
5/8 x 1-3/4	210030GA	36/100
5/8 x 2	210031GA	68/100
5/8 x 2-1/4	210032GA	42/100
5/8 x 2-1/2	210033GA	43/100
5/8 x 3-1/4	210072GA	45/100
3/4 x 1-3/4	210046GA	58/100
3/4 x 2	210047GA	61/100
3/4 x 2-1/4	210048GA	62/100
3/4 x 2-1/2	210048GA	66/100
3/4 x 2-3/4	210050GA	70/100
3/4 x 4-1/2	210057GA	91/100
3/4 x 5	210058GA	94/100
3/4 x 5-1/2	210059GA	104/100
7/8 x 2-1/4	210061GA	94/100
7/8 x 3-1/2	210063GA	113/100
1 x 4-1/4	210069GA	172/100
1 x 5-1/2	210070GA	197/100
1 x 6	210164GA	204/100

THREAD LENGTHS

Bolt Diameter	Thread Length (inches)
1/2"	1
5/8"	1.25
3/4"	1.38
7/8"	1.5
1"	1.75
1-1/8"	2
1-1/4"	2
1-3/8"	2.25
1-1/2"	2.25

Pal nuts included with assembly P/N shown.
Add suffix from page 288 for other nut locking device.

U-BOLTS, SQUARE BEND, GALVANIZED

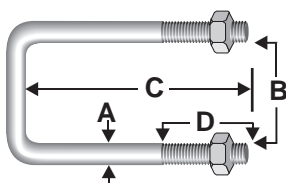

Dimensions (inches)				Assy. Part No.	Weight (lbs/100pcs)
A	B	C	D		
1/2	3-1/4	4-3/8	1-1/4	JR811A	73/100
1/2	4-1/4	5-5/16	1-1/4	JR812A	87/100
1/2	4-1/4	5-13/16	1-3/4	JR812LA	91/100
1/2	6-1/4	7-13/16	1-3/4	JR815A	119/100
3/4	6-1/4	8-1/2	2-1/2	JR12685SQA	277/100

Pal nuts included with assembly P/N shown.
Add suffix from page 288 for other nut locking device.



NUTS, BOLTS & WASHERS

U-BOLTS, ROUND BEND, GALVANIZED

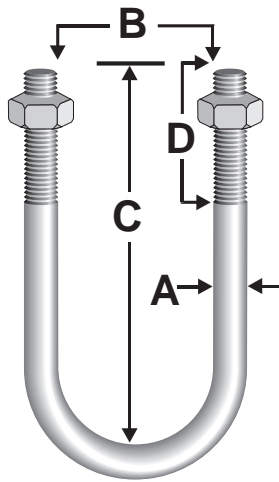

Dimensions (inches)				Assy. Part No.	Weight (lbs./100pcs)
A	B	C	D		
1/4	1-1/4	2-1/4	1-3/8	JR45GA	12/100
5/16	1-1/2	2-5/8	1-1/4	JR51A	15/100
5/16	1-1/2	2	1-1/4	JR55A	14/100
5/16	1-11/16	2-1/4	1	JR54A	15/100
3/8	13/16	1-5/8	7/8	JR69A	21/100
3/8	1	2-1/4	1-1/4	JR67A	23/100
3/8	1-1/4	2-3/4	1-5/8	JR66A	31/100
3/8	1-1/2	3	1-3/4	JR65A	29/100
3/8	2-1/8	3	1-1/4	JR68A	31/100
3/8	2-1/2	4	2	JR60A	35/100
3/8	2-1/2	3-1/2	1-1/2	JR61A	33/100
3/8	3-1/2	4-5/8	1-5/8	JR64A	41/100
3/8	4	6	2-1/4	JR62A	42/100
3/8	4-1/2	6-1/2	2-1/4	JR63A	52/100
1/2	3/4	3-1/2	2-1/2	JR81A	60/100
1/2	2	3-3/4	1-3/4	JR810A	63/100
1/2	2-1/4	4-1/2	2-1/4	JR82A	71/100
1/2	2-1/2	4-1/2	2-1/2	JR83A	71/100
1/2	3	5-5/8	3	JR84A	84/100
1/2	3	4-1/8	1-1/2	JR84SA	73/100
1/2	3-1/2	6	3	JR88A	88/100
1/2	4	6-1/2	3-1/2	JR89A	98/100
1/2	4-1/2	6	2-1/4	JR85A	91/100
1/2	5-5/8	8	3-1/4	JR86A	114/100
1/2	6-3/4	9	3-1/4	JR87A	127/100
1/2	8-3/4	11-1/8	2-1/2	JR90SA	188/100
1/2	10-7/8	13	2-1/2	JR110A	198/100
1/2	12-7/8	15	2-1/2	JR120A	243/100
3/4	3	5-3/4	3	JR121A	199/100
3/4	3-1/2	6-1/4	2-3/4	JR122A	263/100
3/4	4	6-3/4	2-1/2	JR123A	284/100
3/4	4-1/2	7-1/4	2-1/2	JR124A	280/100
3/4	5-5/8	8-5/16	2-1/2	JR125A	318/100
3/4	6-3/4	10	3-1/2	JR126STA	390/100
3/4	8-3/4	11-3/8	2-1/2	JR128A	424/100
3/4	10-7/8	13-3/8	2-5/8	JR1210A	517/100
3/4	12-3/4	15	2-1/2	JR1212A	591/100

Pal nuts included with assembly P/N shown.
Add suffix from page 288 for other nut locking device.

NUTS, BOLTS & WASHERS

J-BOLTS, GALVANIZED

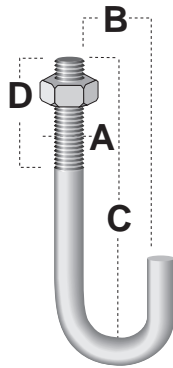

Dimensions (inches)				Assy. Part No.	Weight (lbs./100pcs)
A	B	C	D		
3/8	5/8	4	2-5/8	J44AA	16/100
3/8	5/8	5-11/16	2-3/4	J51A	23/100
3/8	5/8	7-9/16	5-1/2	J170A	35/100
3/8	3/4	2	1-1/2	J167A	10/100

Pal nuts included with assembly P/N shown.
Add suffix from page 288 for other nut locking device.

U-BOLTS, DOUBLE BEND, GALVANIZED

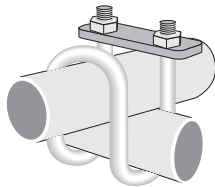

Description	Assy. Part No.	Weight (lbs./100pcs)
5/16" dia. (18 THD) For 1-1/4" Tubing	TB5125BA	54/100

BASE BOLT, GALVANIZED

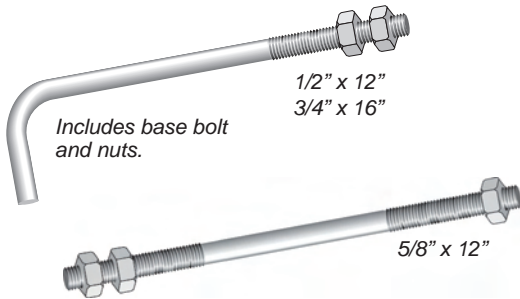

Description	Part No.	Weight (lbs.)
1/2" x 12" + 2" (Hook)	1/2X12BB	1/2 ea.
5/8" x 12"	260145G	1 ea.
3/4" x 16" + 3" (Hook)	3/4X16BB	1-1/2 ea.

STEP BOLT, GALVANIZED



Description	Part No.	Weight (lbs./100pcs)
5/8" x 7" (2-1/2" THD Length)	210042G	84/100
5/8" x 7" (2-1/2" THD Length) With 2 Heavy Hex Nuts	5/8STEP	108/100



NUTS, BOLTS & WASHERS

Plain Nut

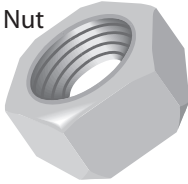

Pal Nut
(used with plain nut)

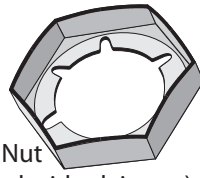

Tri-Loc Nut



Anco Nut



HEAVY HEX NUT OPTIONS, GALVANIZED

Description	Plain Nut	Weight (lbs./100pcs)	Pal Nut P/N	Weight (lbs./100pcs)	Tri-Loc P/N	Weight (lbs./100pcs)	Anco P/N	Weight (lbs./100pcs)
3/8" - 16	230005	3/100	110159	0.4/100	38CTLFG/2H	3/100	230008	3/100
1/2" - 13	110143	7/100	110160	1/100	50CTLFG/2H	7/100	110581	7/100
5/8" - 11	110146	12/100	110161	1/100	58CTLFG/2H	12/100	110510	12/100
3/4" - 10	230020	19/100	110162	2/100	75CTLFG/2H	19/100	110511	19/100
7/8" - 9	110149	30/100	110163	2/100	78CTLFG/2H	30/100	110512	30/100
1" - 8	110150	43/100	110164	4/100	1CTLFG/2H	43/100	110513	43/100

HARDENED FLAT WASHERS, GALVANIZED

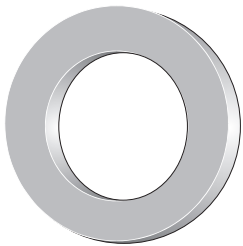

Plain Washer



Split Ring Washer

Description	Plain Washer	Weight (lbs./100pcs)	Split Ring Washer	Weight (lbs./100pcs)
3/8"	110950	1/100	250082	1/100
1/2"	110202	2/100	250083	2/100
5/8"	110205	3/100	250084	3/100
3/4"	110208	5/100	250042	5/100
7/8"	110210	6/100	250046	10/100
1"	110214	8/100	250047	10/100

NUTS, BOLTS & WASHERS

BEVELED WASHERS, GALVANIZED

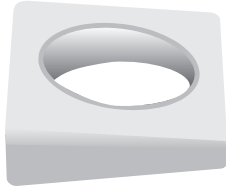

Description	Part No.	Weight (lbs./100pcs.)
3/8"	110398	7/100
1/2"	110399	7/100
5/8"	110400	15/100
3/4"	110551	14/100
7/8"	250062G	31/100
1"	110686	28/100

ROHN GUY MATERIALS

THIMBLES, GALVANIZED



Description	Assy. Part No.	Weight (lbs./100pcs.)
1/4" Standard thimble, open for 1/8" to 3/16" guys	1/4TH	4/100
5/16" Heavy duty thimble, open for 3/16" guys	5/16THH	12/100
3/8" Heavy duty thimble, open for 1/4" guys	3/8THH	25/100
7/16" Heavy duty thimble, open for 5/16" guys	7/16THH	30/100
1/2" Heavy duty thimble, open for 3/8" guys	1/2THH	51/100
9/16" Heavy duty thimble, open for 7/16" guys	9/16THH	51/100
5/8" Heavy duty thimble, open for 1/2" or 9/16" guys	5/8THH	75/100
3/4" Heavy duty thimble, open for 5/8" guys	3/4THH	147/100
7/8" Heavy duty thimble, open for 3/4" guys	7/8THH	175/100
1" Heavy duty thimble, open for 7/8" guys	1THH	275/100